

NAME: LED Corn Light

P/N: NLS-CL-40W

Advantage

- CE RoHS certificate
- E26/E27/E39/E40 lamp base
- Warm / Natural / Cool / Cold white
- 360degree lighting, high CRI
- Big heat sink
- Internal driver, input voltage AC85-300V or DC12-24V
- No UV or IR in the beam
- Easy to install and operate
- Energy saving, long service life
- Light is soft and uniform, safe to eyes
- Instant start, NO flickering, NO humming
- Green and eco-friendly without mercury



Application

Widely used in supermarket, warehouse, garage, home, office, hotel, hospital, school, street, garden etc.

NEWLITE SOLUTIONS LTD

PRODUCT SPECIFICATIONS				
Product name	LED Corn Light			
Part No	NLS-CL-40W			
Light Type	Corn Light			
Dimension	Φ 93*208mm			
Technical Characteristic				
Color	Warm white	Natural white	Cool white	Cold white
Color temperature	2700-3000K	4000-4250K	6000-6500K	7000-8000K
CRI	> 70	> 70	> 70	> 70
Lumen	4180.0	4340.0	4504.0	4424.0
Lumen Efficacy	104.5	108.5	112.6	110.6
Input Power	40 W			
Viewing Angle	360 degree			
Input Voltage	AC85-300V or DC12-24V 50/60Hz			
PFC	>90%			
Equivalent	300W incandescent / 80W CFL			
Waterproof Rating	IP20			
MATERIALS				
LED Brand	EPISTAR			
LED Type	SMD2835			
LED QTY	210 PCS			
Housing	PC			
Housing color	White			
OTHERS				
Operating Temperature	-20°C TO 45°C			
Operating Humidity	20%-70% RH			
Storage Temperature	-30°C TO 80°C			
Storage Humidity	10%-75% RH			
Application	Indoor			
Environment Protection	RoHS			
Safety Certification	CE			
Warranty Time	3 Years			

Measured Data of Lamp			
Voltage: 228.2 V	Current: 0.186 A	Power: 40.9 W	Power Factor: 0.963
Total Flux	3938.40 lm	Central Intensity	779.89 cd
Lamp Efficiency	0.00%	Light Efficiency	96.29 lm/W
Peak Intensity	1337.98 cd	Location of Peak(c, γ)	(320.0°, 25.2°)
Half-Intensity Angle	118.8°	BeamAngle	162.9°
Upward Light Ratio	0	Downward Light Ratio	100%
Upward Street Side	0	Downward Street Side	1846.42 lm
Upward House Side	0	Downward House Side	2091.85 lm
Flash Area(76°)	0 cm ²	Discomfort Glare(SLI)	0

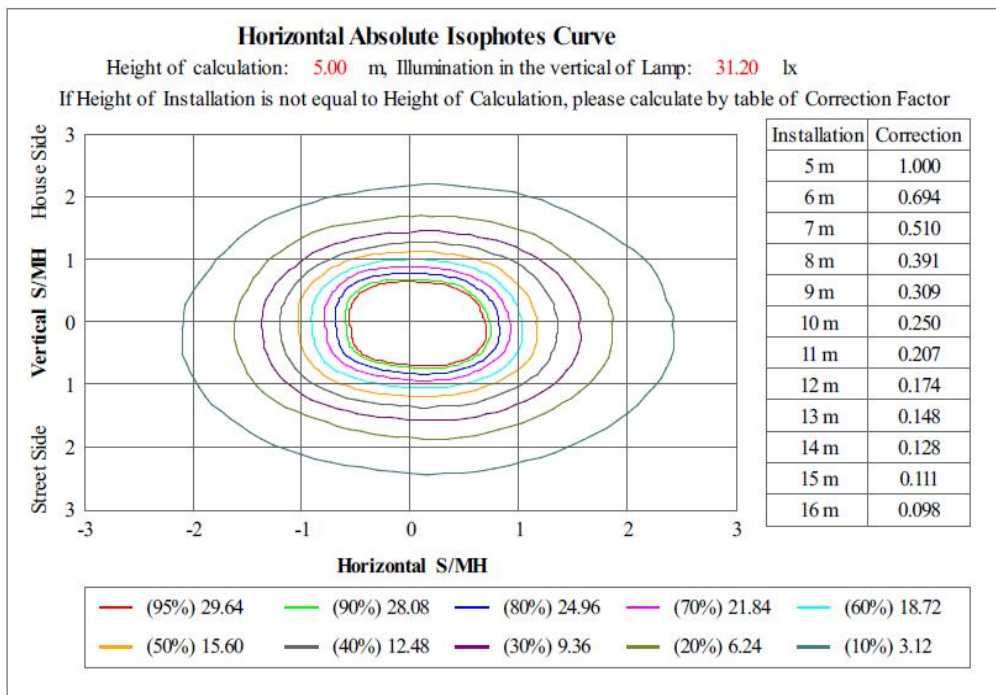
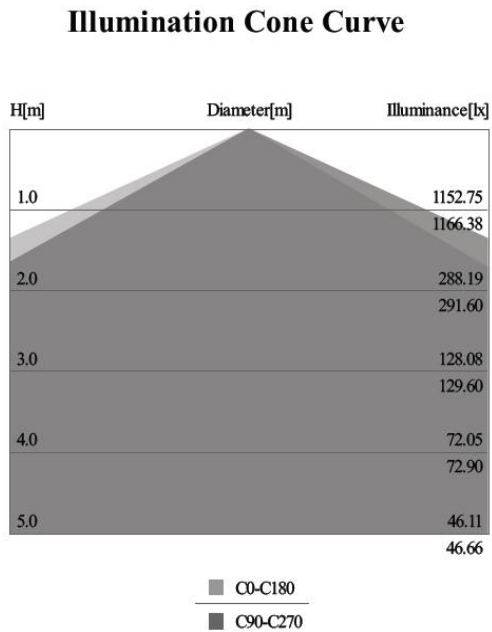
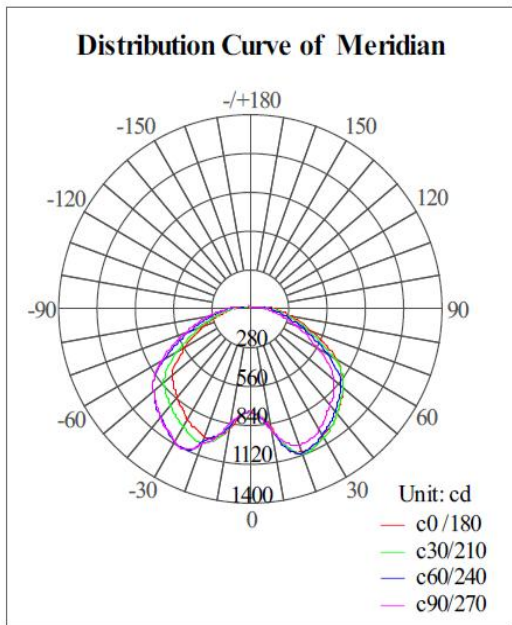

Package

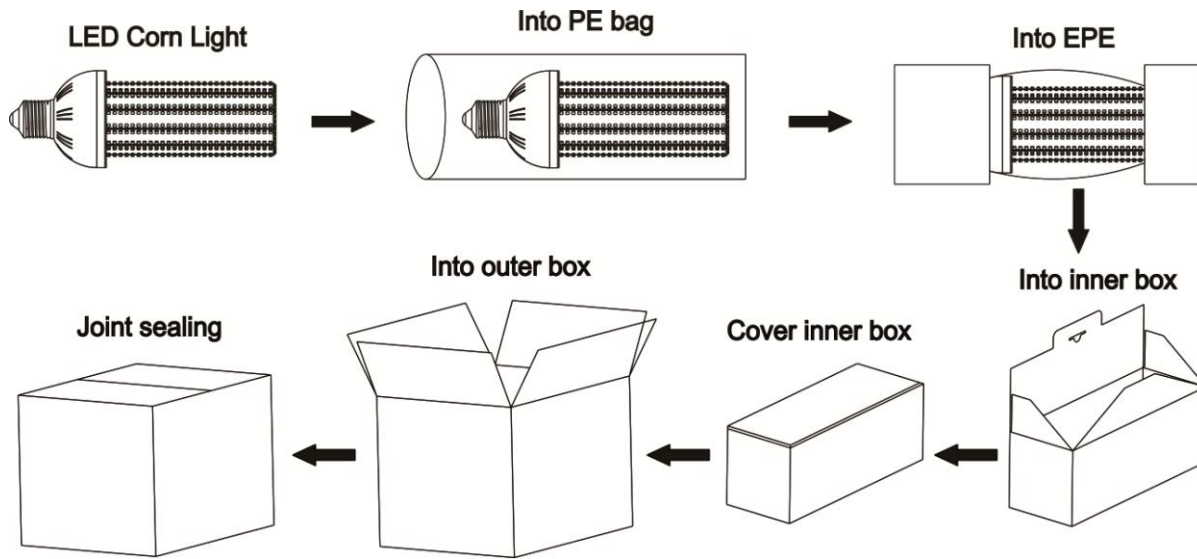

	Size	Qty/ Carton	Net Weight/ Carton	Gross Weight/ Carton
inner box	305*115*115mm	1	0.37kg	0.52kg
outer box	610*320*250mm	10	3.7kg	5.7kg

Notice For User

- Please turn off power before install or change assembly parts.
- The input voltage and lamps should be matched, after connecting the power line, please make sure the wiring section is insulated.
- Make sure to remove or bypass the electronic ballast in the fixtures before install the lamps.
- 15W/20W with internal driver are suitable for closed fixtures, 30W/40W/60W/80W/100W/120W, please don't use the lamps in closed fixtures, for closed fixtures, we suggest using external drive for the lamps.
- No-professionals, must not install and disassemble the lamps.

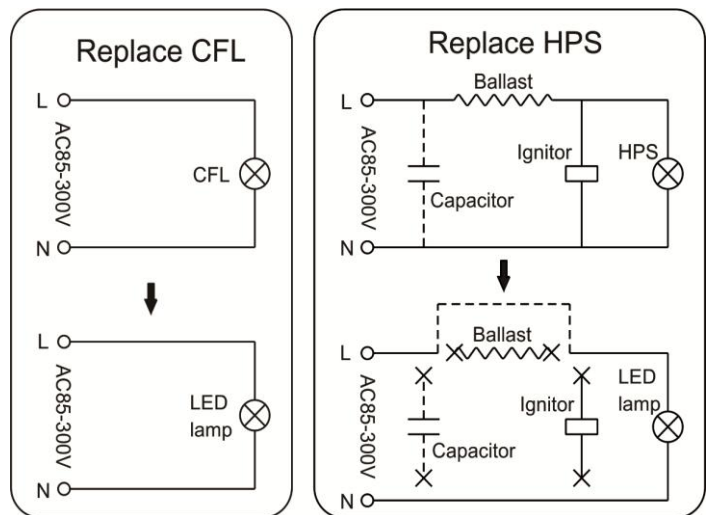

Trouble Shootings

Troubles	Check points
Flickering of the lamps	Turn off the power and turn on again in 3 minutes. If same phenomena occur, then call agencies
Out of working	Please check the connection

NEWLITE SOLUTIONS LTD